

# FORRO SIMPLEX 10

medidas mm

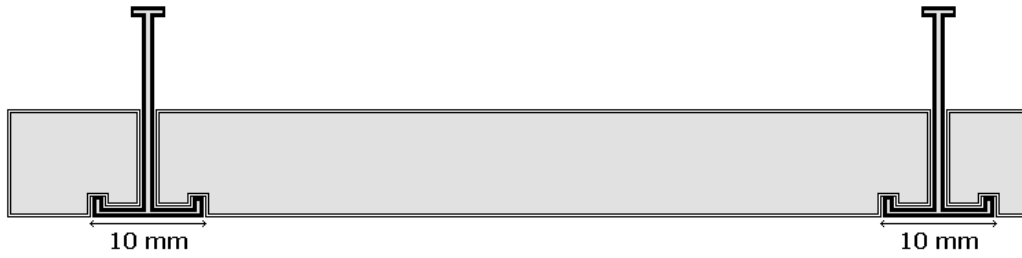

Modulação



625 X 625

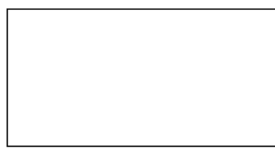

625 X 1.250



500 X 625

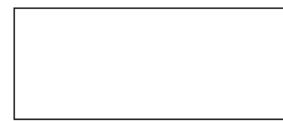

500 X 1.250

Placas



623 X 623



623 X 1.248



498 X 623



498 X 1.248

Difusores

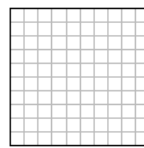

625 X 625



625 X 1.250

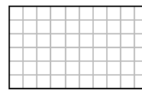

375 X 625

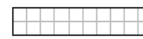

125 X 625

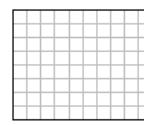

500 X 625

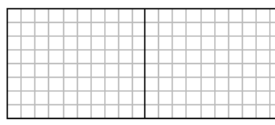

500 X 1.250

## Medidas das placas integradas

placa 623 x 623

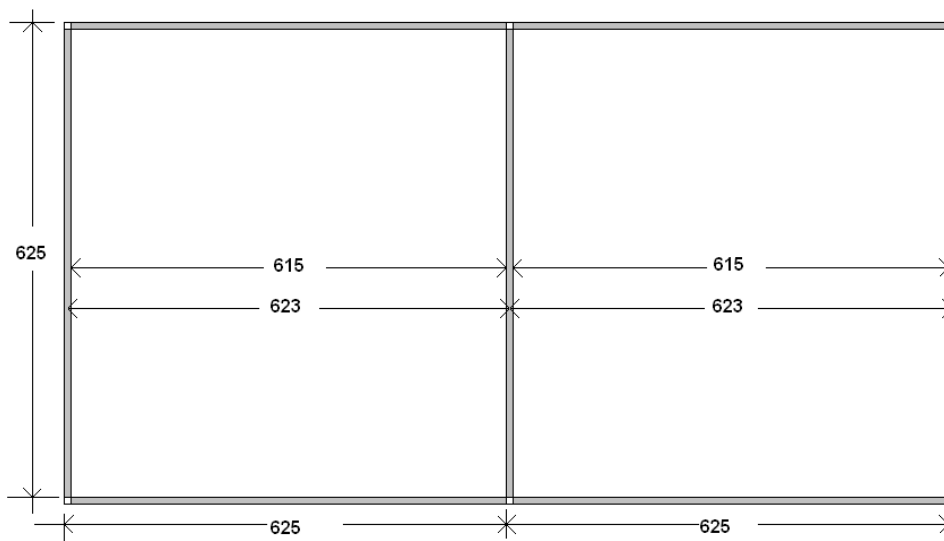

## SISTEMA T10

placa 623 x 1248

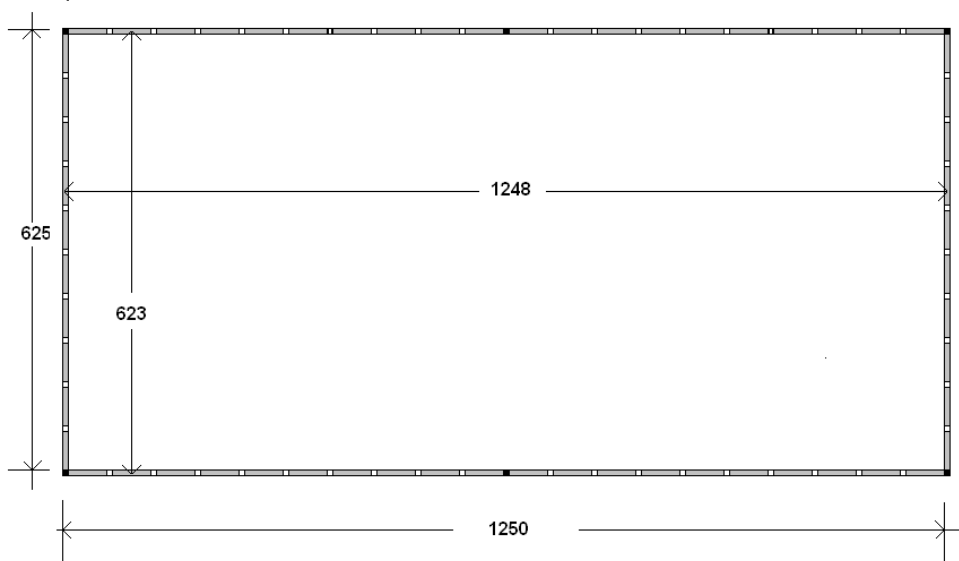

medidas em mm



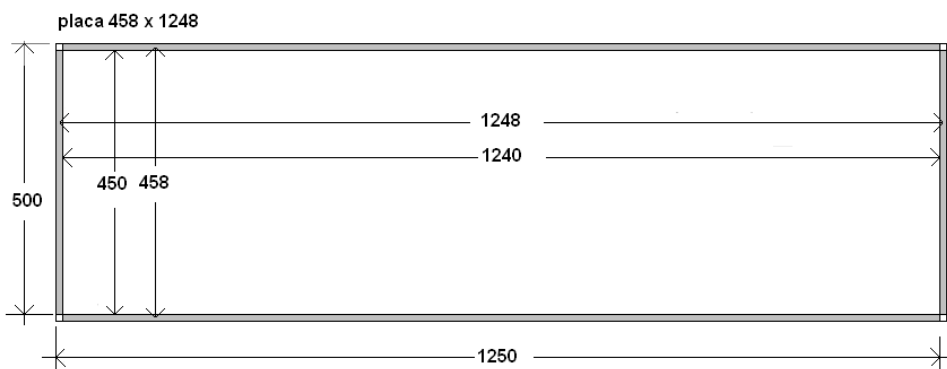
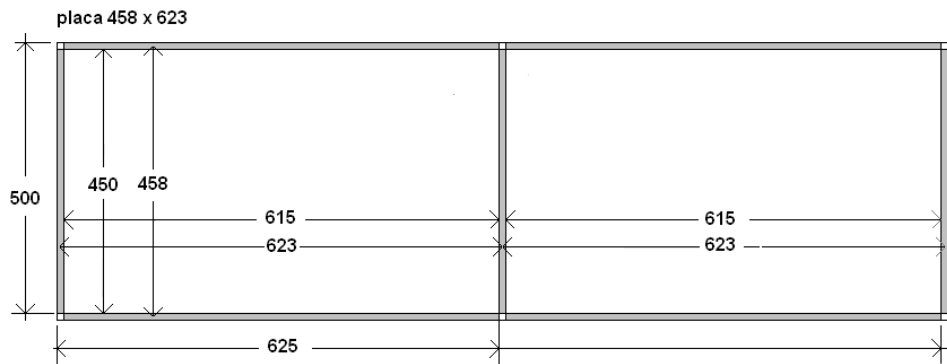

***Colméias monolíticas sistema: T10***  
Apropriado para áreas internas com manutenção acima do plenum

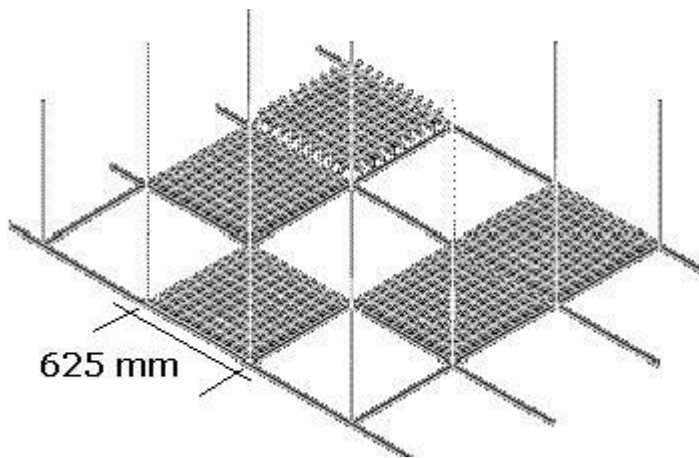

Travessas e perfis principais em alumínio extrudado na mesma cor das cédulas tornando o forro um sistema monolítico. Sob consulta poderá ser pintadas travessas e perfis principais em outra cor a sua escolha. Cédulas em alumínio laminado pré pintado

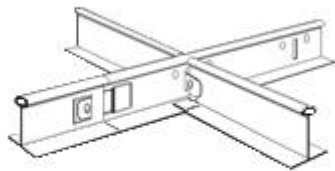

SISTEMA T10 permite colocação rápida exclusiva devido ao tipo de encaixe "clik", sem necessidade de peças de fixação ou parafusos. Oferece perfeito alinhamento das placas, pois suas abas são rígidas (Perfil solido) sem dobramentos que enfraquecem e deformam o perfil. Por ser extrudado de alumínio (solido) não enferruja e na manutenção não sofre danos, não amassa e nem deforma, condição indispensável na manutenção das instalações interferentes ao forro ou na alteração futura de layout.

- mesmas características para sistema T25

## MODELOS

### 52/25 T10



#### Modelo 52/25 AL T10

Material alumínio pré pintado

Módulos 62,5 x 62,5 cm

Abertura cédula 5,2 x 5,2 cm

Altura 2,5 cm

Perfil principal 250 cm

Travessa 62,5 cm

Cores std – branco – prata – preto – Qualquer outra cor sobre encomenda

### 52/37 T10

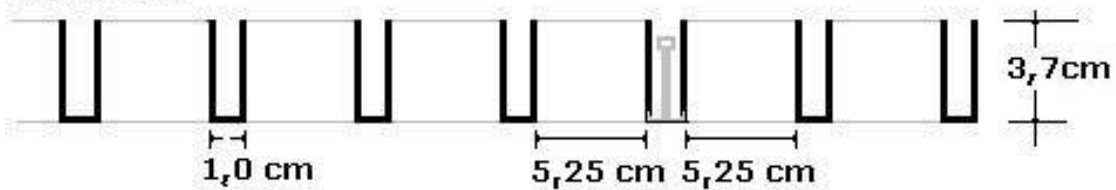

#### Modelo 52/37 AL T10

Material alumínio pré pintado

Módulos 62,5 x 62,5 cm

Abertura cédula 5,2 x 5,2 cm

Altura 3,7 cm

Perfil principal 250 cm

Travessa 62,5 cm

Cores std – branco – prata – preto – Qualquer outra cor sobre encomenda

### 11/25 T10

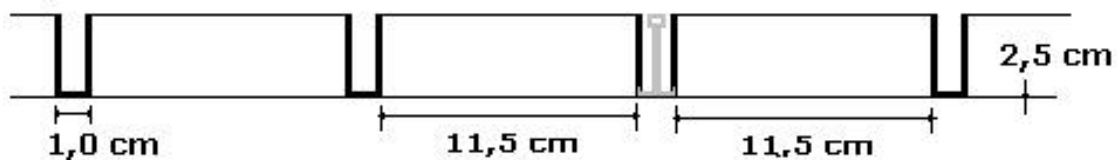

#### Modelo 11/25 AL T10

Material alumínio pré pintado

Módulos 62,5 x 62,5 cm

Abertura cédula 11,5 x 11,5 cm

Altura 2,5 cm

Perfil principal 250 cm

Travessa 62,5 cm

Cores std – branco – prata – preto – Qualquer outra cor sobre encomenda

### 11/37 T10

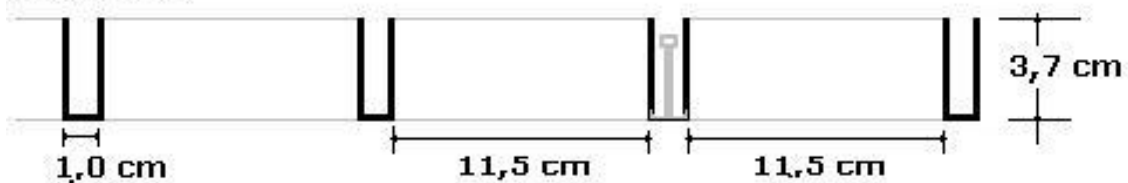

#### Modelo 11/37 AL T10

Material alumínio pré pintado

Módulos 62,5 x 62,5 cm

Abertura cédula 11,5 x 11,5 cm

Altura 3,7cm

Perfil principal 250 cm

Travessa 62,5 cm

Cores std – branco – prata – preto – Qualquer outra cor sobre encomenda

**SISTEMA T10**  
CÉDULA 52

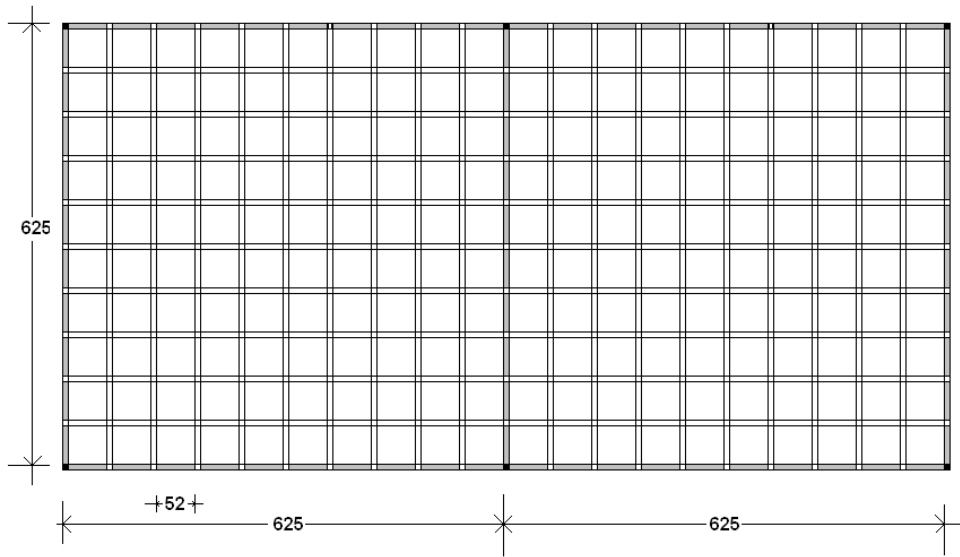

medidas em mm

**SISTEMA T10**  
cédula 115

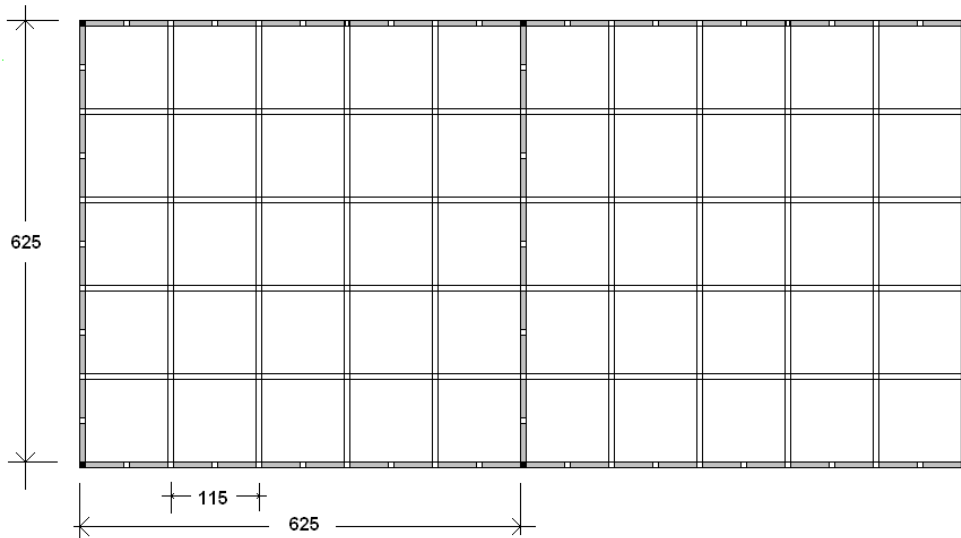

medidas em mm

### SISTEMA T10

### MEDIDAS RECOMENDADAS PARA LUMINARIAS E SPOT

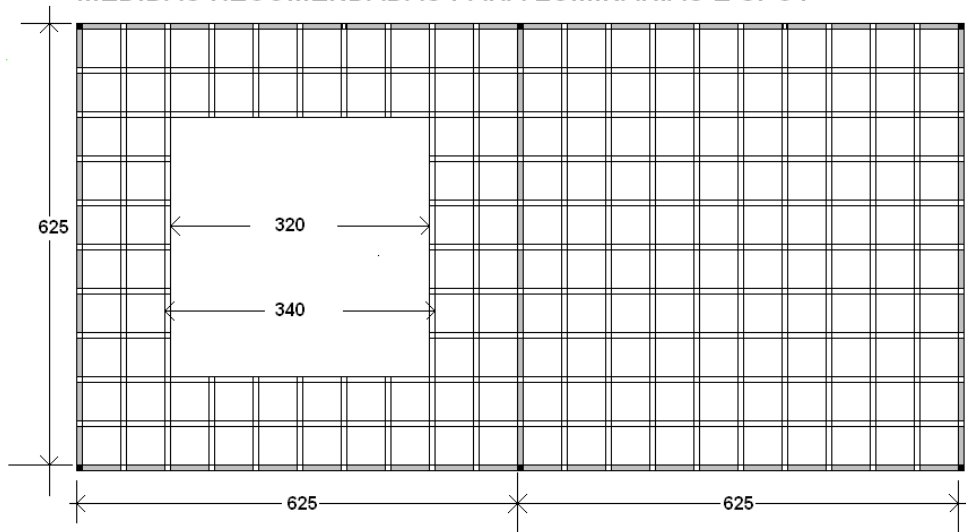

medidas em mm

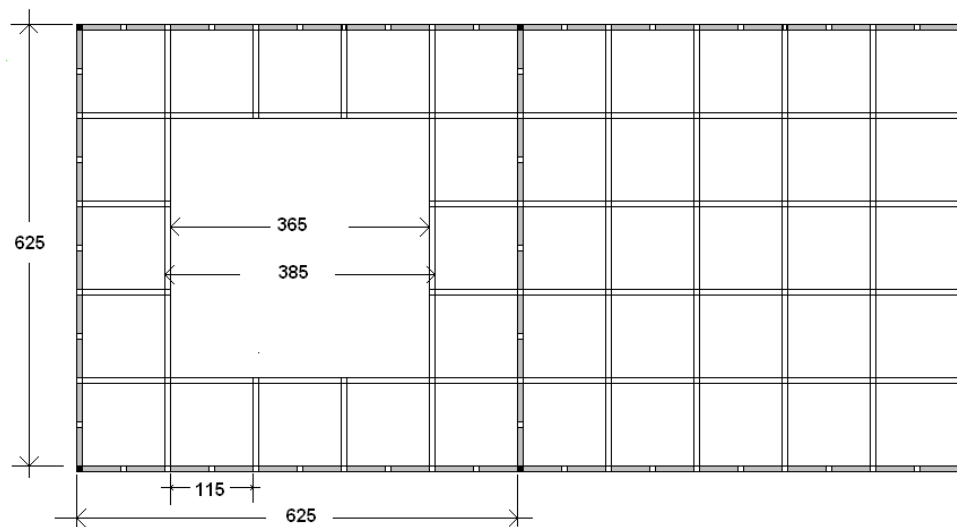

medidas em mm

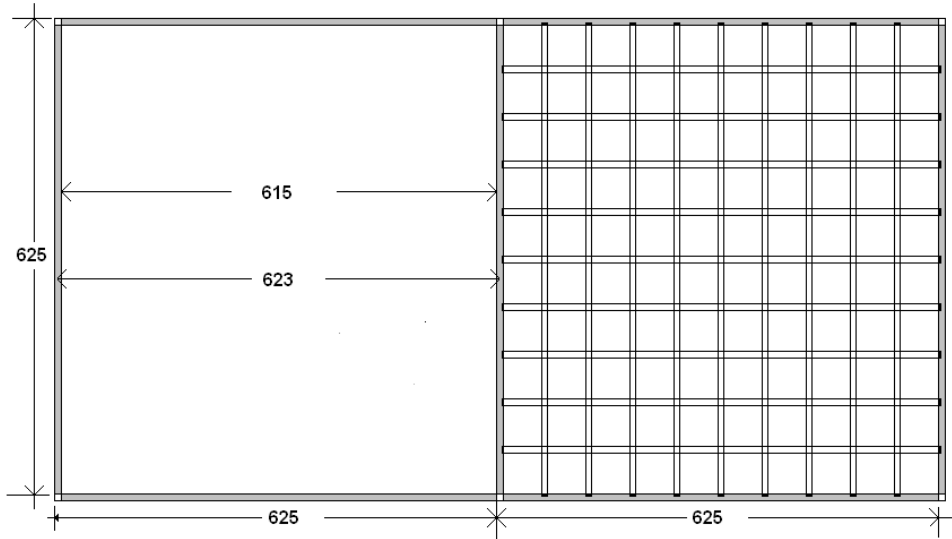

medidas em milímetros

MEDIDAS LUMINARIA MODULO 625 X 1250

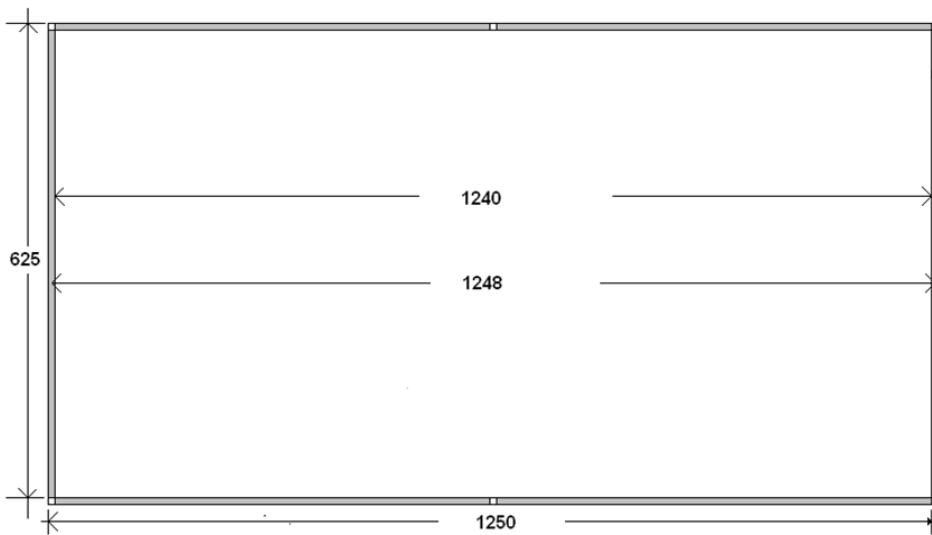

medidas em milímetros